

Air Source Heat Pump Guide



joule
Manufacturing Excellence

SAMSUNG

PACKAGED HEAT PUMP SOLUTIONS

INTRODUCING THE JOULE AIR SOURCE HEAT PUMP POWERED BY SAMSUNG

The ultimate in home climate convenience is here, thanks to ClimateHub - Samsung's new integrated solution for heating and domestic hot water supply.

With straightforward installation, smooth commissioning, quiet operation and smart connectivity, maintaining home comfort has finally been made easy.



The Technology - Air Source Heat Pumps

A heat pump is an energy-efficient system that uses the heat from the ambient air for heating and hot water. By using the ambient air and transferring this heat into the house through a hydronic system, such as underfloor heating, a heat pump requires less power input and offers greater power output than conventional boilers.



Quiet Operation

SAMSUNG IN QUIET MODE IS QUIETER THAN MITSUBISHI ULTRA QUIET

Today's climate systems need to meet increasingly strict sound level requirements and limit aural disturbance around the home. The Samsung ClimateHub system's 4-Step Quiet Mode allows users to reduce noise levels of the heat pump outdoor unit to as low as 35dB(A).



Smart Connectivity

CONNECTS INTO SMART THINGS CONTROL ENVIRONMENT

The ClimateHub system can be managed remotely. Using the optional Wi-Fi kit, users can control different aspects of the system through the Samsung SmartThings app - turn it on and off, control the functions and schedule its operation, from anywhere

How it works?

A heat pump is an electrical device that extracts heat from one place and transfers it to another. The heat pump is not a new technology; it has been used around the world for decades. Refrigerators and air conditioners are both common examples of this technology.

Heat pumps transfer heat by circulating refrigerant through a cycle of evaporation and condensation. A compressor pumps the refrigerant between two heat exchanger coils. In one coil, the refrigerant is evaporated at low pressure and absorbs heat from its surroundings.

The refrigerant is then compressed en route to the other coil, where it condenses at high pressure. At this point, it releases the heat it absorbed earlier in the cycle.

Refrigerators and air conditioners are both examples of heat pumps operating only in the cooling mode. A refrigerator is essentially an insulated box with a heat pump system connected to it.

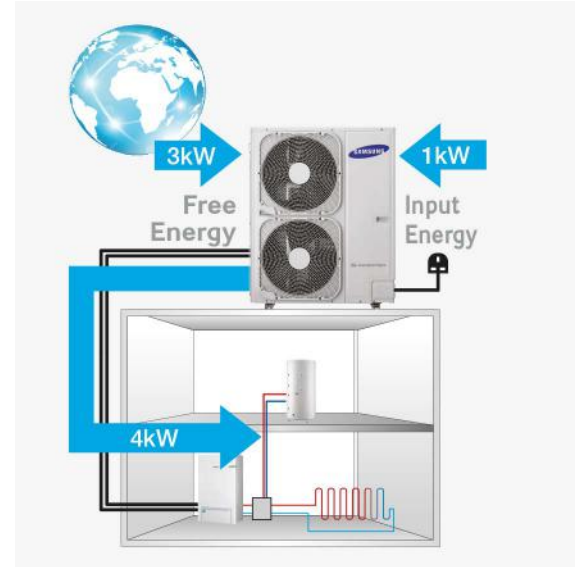

**For every 1 kWh
of energy input**

=

An air source heat pump
can deliver up to more than
4 kWh in energy output.

This is an energy efficiency ratio of more than **400%**, which is far superior to high energy efficiency boiler systems. Our heatpump packages have class leading SCOP.

Air Source Heat Pump Benefits

- Compatible with all low temp. systems
- High seasonal energy efficiency
- Up to 60°C water supply
- Easy to install - Easy to control
- Operation Range down to -20°C
- Higher capacity at low ambient temperature

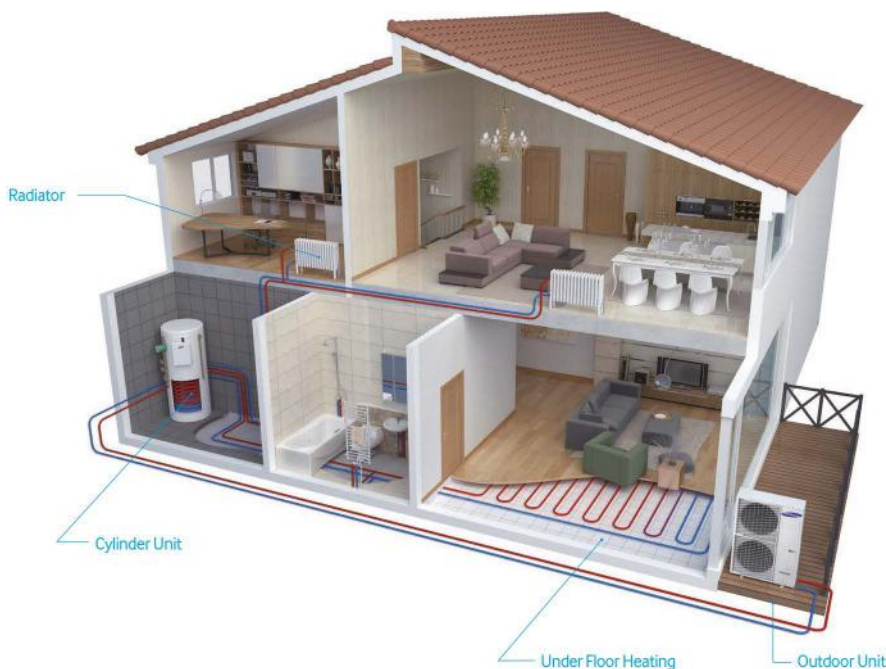

— Water Pipe (Supply)
— Water Pipe (Return)

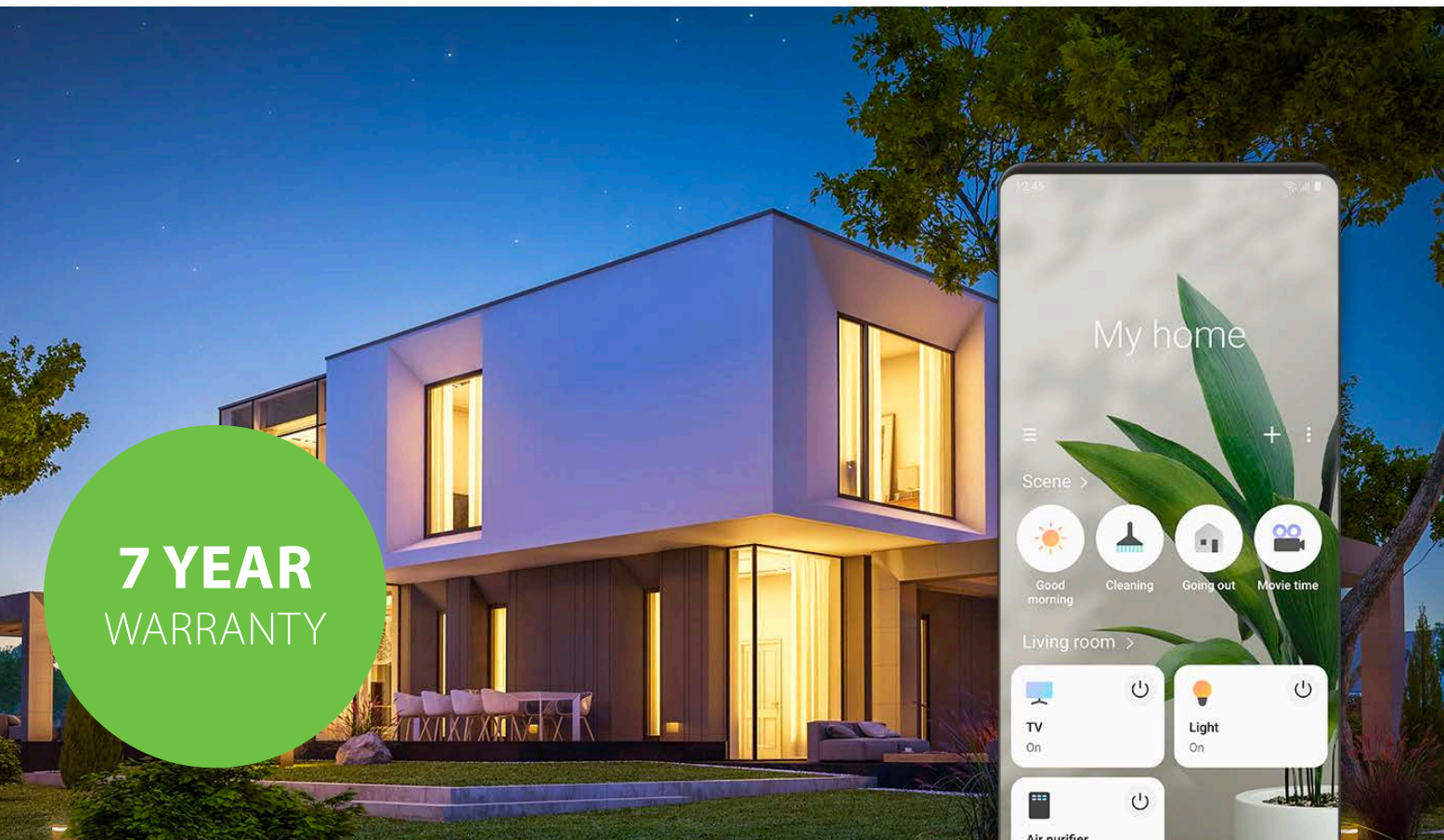

**7 YEAR
WARRANTY**

Hands-free control.

Use Bixby on your Galaxy phone to control your smart devices with your voice.



Smart Applications:

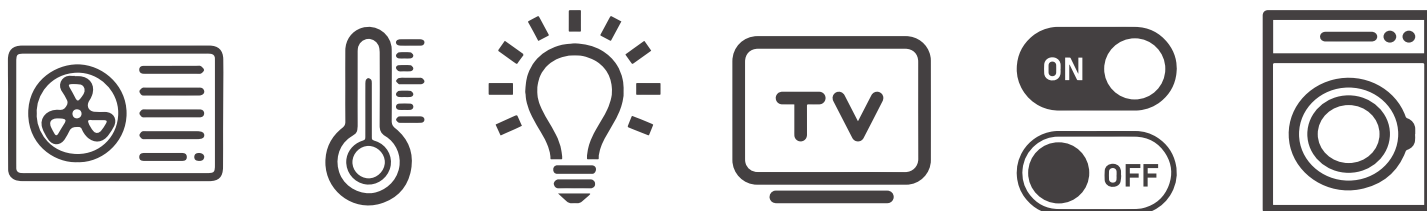

More available at: <https://www.samsung.com/uk/apps/smartthings/>

More smart devices, one smart app.

Connect, automate, and manage all your Samsung and SmartThings-compatible appliances and electronics with a single, easy-to-use app.

Because smart should be simple, however many devices you bring home.

CONNECTS INTO SMART THINGS CONTROL ENVIRONMENT

Connect to your heatpump and smart cylinder from the comfort of your living room.



One app, multiple screens.

Access SmartThings features across a family of Samsung products, including smart phones, TVs, and fridges.

Your home, your way.

Make your home smarter with custom automation. Create schedules and scenarios, and let SmartThings do the rest.

It can even suggest new smart ways to automate your day.

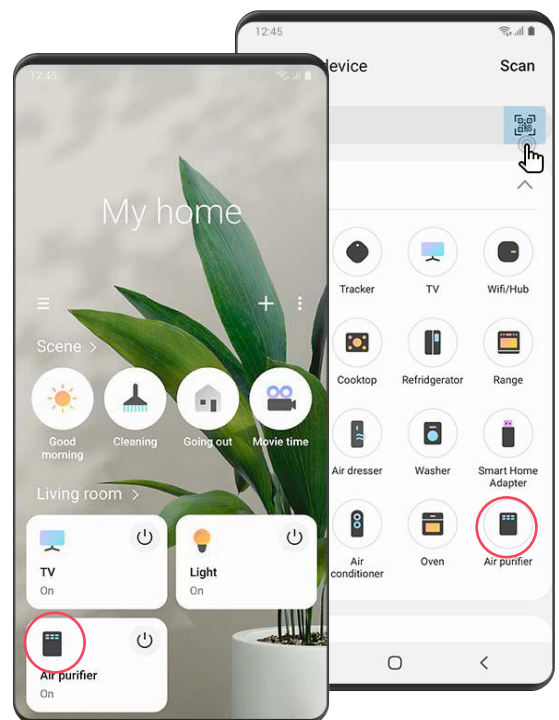



Compact Design

The Joule compact solution is built around a compact tank integrated hydro unit, with a large domestic hot water tank of either 180L or 230L.

The compact and modular design makes for straightforward kitchen or utility room integration.

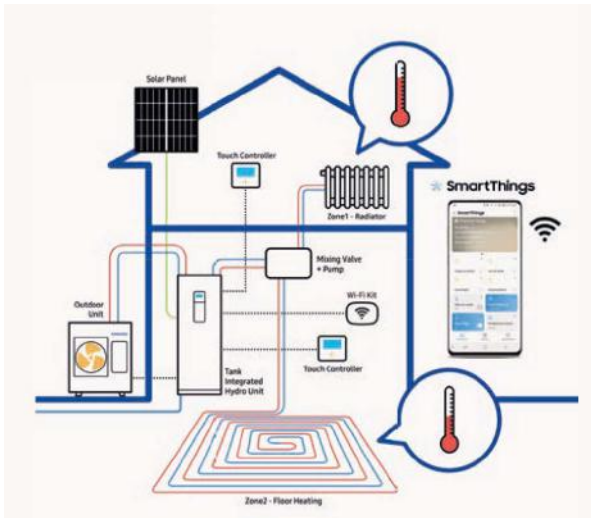

Smart Connectivity

The new touch controller enables users to manage differing temperature settings per zone, meaning high-temperature radiators and low-temperature floor heating can be utilised efficiently.

Using the optional Wi-Fi Kit, the different aspects of the system can be controlled through the Samsung SmartThings app.

App on your smartphone.*
(Android and Apple compatible)



CAN CONTROL UP TO 2 ZONES - USING REMOTE SENSOR

The new Samsung touch screen controller with multiple language options and bright colour display - enabling temperature settings, energy monitoring, ensures the system delivers efficient comfortable heating thanks to its in-built weather compensation controls.

**** Our packages come complete with free training.***

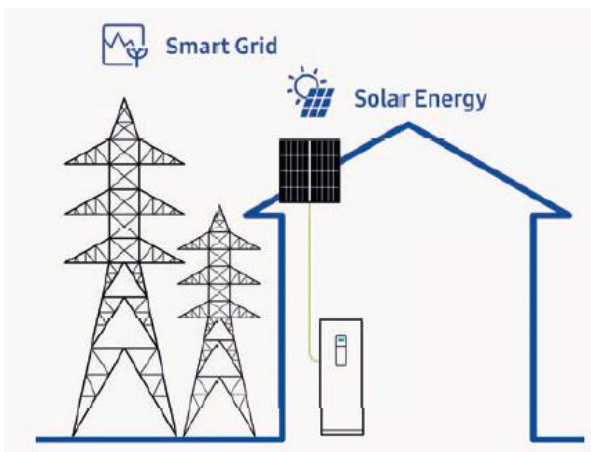

Smart Grid Ready & PV Enabled

A Smart Grid efficiently integrates the behaviour and actions of all the users connected to it. Smart Grid readiness enables users to benefit from an economically efficient and sustainable power supply. Thanks to the PV (Photovoltaic or 'solar' energy) enabled feature, the system can be connected to solar panels, saving energy through renewable sources.*

Microgeneration Certification Scheme

- SAMSUNG MONOS ARE TOP PERFORMING MODELS AS PER MCS LEAGUE TABLE
- MCS COMPLIANT ENERGY MONITORING ON BOARD AS STANDARD



The complete range of Joule heating products has received full accreditation for the Government's Microgeneration Certification Scheme (MCS).

In addition to certifying heating products the MCS process also looks at the companies installing this type of equipment so that customers can take real confidence that they will get the performance and service expected. MCS is designed to evaluate products and installers against criteria for microgeneration technologies, thereby providing greater consumer protection. An MCS approved product, such as Samsung, installed by an MCS approved installer is a requirement to apply for the Government's Renewable Heat Incentive (RHI).

Renewable Heat Incentive, RHI

Joule in cooperation with Samsung provides a proven, efficient way of heating buildings. The Government will now pay for the generation of renewable heat through the Renewable Heat Incentive (RHI). This has been designed to level the playing field between the cost of renewable and traditional fossil fuel systems. Switching to heating systems that use eligible energy services can help the UK reduce its carbon emissions and meet its renewable energy targets.

Product Characteristics Database, PCDB

The PCDB, formerly known as SAP Appendix Q, allows you to enter performance data specific to Samsung rather than using the default air source heat pump data in SAP. This enables a higher efficiency to be shown within the SAP calculations for the property.

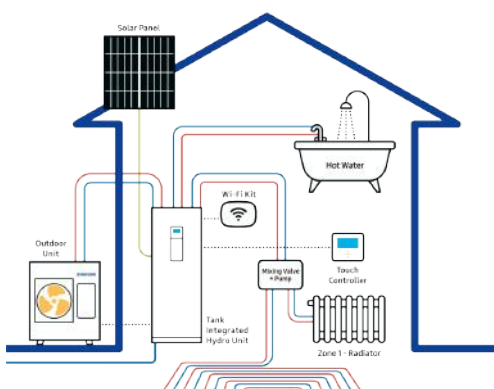

Joule ClimateHub Mono

The ClimateHub Mono configuration has a single outdoor unit that includes the hydronic system, making it easy to install and use.

The system's potential can be maximised by connecting to **Smart Grid** or **Solar Power (PV)**.

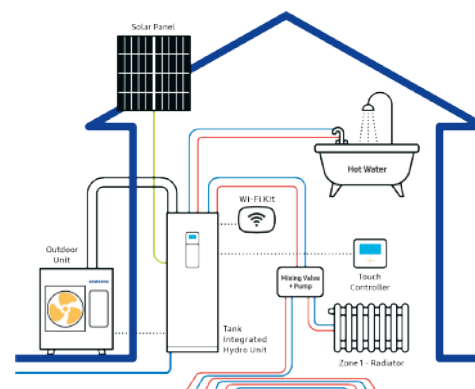

Joule ClimateHub Split

The ClimateHub Split configuration has a single outdoor unit, connected by refrigerant pipes to the tank integrated hydro unit.

To maximize its potential, the system has **PV export functionality and Smart Grid ready**

Joule-Samsung

Air Source Heat Pump Product Range



R32 Outdoor Unit

HHSM -G600005-1	HHSM -G600008-1	HHSM- G600012-1	HHSM- G600016-1	HHSM G600016-3
--------------------	--------------------	--------------------	--------------------	-------------------

Capacity		5kW	8kW	12kW	16kW	16kW
Power		1Φ				3Φ
Packaged						
HUGH-180COM-3C	180L COMPACT	●	●	●	●	
HUGH-230COM-3C	230L COMPACT	●	●	●	●	
Pre-Plumbed						
HUGH-G6150-L3C	150L STANDARD	●	●			
HUGH-G6170-L3C	170L STANDARD	●	●	●		
HUGH-G6200-L3C	200L STANDARD	●	●			
HUGH-G6250-N3C	250L STANDARD		●	●	●	●
HUGH-G6300-N3C	300L STANDARD			●	●	●
HUGH-G6150-S3C	150L SLIMLINE	●	●			
HUGH-G6170-S3C	170L SLIMLINE	●	●	●		
HUGS-G6200-L3C	200L SOLAR	●				
HUGS-G6250-N3C	250L SOLAR			●	●	●
HUGS-G6300-N3C	300L SOLAR		●		●	●
Standalone						
	1PH SO SYS	●	●	●	●	
	3PH SO SYS				●	●
Buffer						
HUGH-G61860-3C	MONO 180/60L	●	●	●		
HUGH-G62060-3C	MONO 200/60L	●	●	●	●	●
HUGH-G62590-3C	MONO 250/90L		●	●	●	●
HUGH-G64013-3C	MONO 300/130L		●	●	●	●
HUGH-G64013-3C	MONO 400/130L			●	●	●



Tank Integrated Hydro Unit & Smart Plumb Cylinder

Joule Air Source Heat Pumps - Specification

Joule-Samsung Mono Specification

R32

A+++



				Outdoor Unit	HHSM-G600005-1	HHSM-G600008-1	HHSM-G600012-1	HHSM-G600016-1	
				Controller	HZSMC-G6000000	HZSMC-G6000000	HZSMC-G6000000	HZSMC-G6000000	
System	Operation	Nominal Capacity	Heating A7/W35 ¹ /A7/W55 ²	W	5.000/4.300	8.000/7.100	12.000/11.300	16.000/15.000	
			Cooling A35/W18 ¹	W	5.000	7.500	12.000	14.000	
		Power Input (Nominal)		Heating A7/W35 ¹ /A7/W55 ²	W	1.030/1.520	1.770/2.530	2.650/3.730	3.620/5.180
				Cooling A35/W18 ¹	W	1.140	1.900	2.770	3.280
			COP (Nominal Heating) A7/W35 ¹ /A7/W55 ²	W/W	4,85/2,83	4,52/2,81	4,53/3,03	4,42/2,90	
			EER (Nominal Cooling) A35/W18 ¹	W/W	4,39	3,95	4,33	4,27	
			SCOP LWT 350 ¹ /550 ²	W/W	4,46/3,2	4,44/3,23	4,69/3,51	4,48/3,53	
			Average Seasonal Space Heating Eff.Class*	-	A+++/A++	A+++/A++	A+++/A++	A+++/A++	
		Current	MCA	A	16,00	22,00	28,00	32,00	
				MFA	A	20,00	27,50	35,00	40,00
		Water Flow Rate	Min	l/min	7,00	7,00	12,00	12,00	
			Max	l/min	48,00	48,00	58,00	58,00	
		Leaving Water Temp	Heating	°C	15-65	15-65	15-65	15-65	
			Cooling	°C	5-25	5-25	5-25	5-25	
		Function	Smart Grid Ready	-	●	●	●	●	
			PV Enabled	-	●	●	●	●	
			2-Zone Control	-	●	●	●	●	
Indoor Compact Unit	Power Supply		0,#,V,Hz	220-240V, 50Hz, 1	220-240V, 50Hz, 1	220-240V, 50Hz, 1	220-240V, 50Hz, 1		
	Water Tank Volume		Litres	180/230	180/230	180/230	180/230		
	Declared Load Profile		L/XL						
	Energy Efficiency Class		-	A	A	A	A		
	Sound	Sound Pressure	Heating/ Cooling Std	dB(A)					
		Sound Power	Heating Std	dB(A)					
	Dimensions	Net Weight		kg	85/90	85/90	85/90	85/90	
Net Dimensions (WxHxD)			mm	1900 x 595 x 625	1900 x 595 x 625	1900 x 595 x 625	1900 x 595 x 625		
Outdoor Unit	Power Supply		0,#,V,Hz	10,220-240V,50Hz	10,220-240V,50Hz	10,220-240V,50Hz	10,220-240V,50Hz		
	Compressor	Type	-	BLDC Twin Rotary	BLDC Twin Rotary	BLDC Twin Rotary	BLDC Twin Rotary		
	Base Heater		-	--	●	●	●		
	Sound	Sound	Heating Std	dB(A)	45	48	50	52	
			Pressure	Cooling Std	dB(A)	45	48	50	54
		Power	Heating Std	dB(A)	61	63	64	66	
			Cooling Std	dB(A)	62	64	65	68	
	Dimensions	Net Weight		Kg	58.5	76	110	110	
		Net Dimensions (WxHxD)		mm	880 x 798 x 310	940 x 998 x 330	940 x 1420 x 330	940 x 1420 x 330	
	Refrigerant	Type		-	R32	R32	R32	R32	
		Factory Charging		tC02e	0,68	0,78	1,49	1,49	
				kg		1,00	1,15	2,20	2,20
	Piping	Water Pipe	Inlet/Outlet	Ø,mm	28/28	28/28	28/28	28/28	
Water Pipe (DHW)		Inlet/Outlet	Ø,mm	22/22	22/22	22/22	22/22		
Operation	Ambient Temperature	Heating	°C	-25-35	-25-35	-25-35	-25-35		
		Cooling	°C	10-46	10-46	10-46	10-46		
		DHW	°C	-25-43	-25-43	-25-43	-25-43		

Maximum Heating Capacity (Integrated Value)

LWT (Leaving Water Temp.), Tamb (Ambient Temp.), HC (Heating Capacity), PI (Power input)

HHSM-G600005-1	LWT(°C) 30		35		40		45		50		55		60		65		
	Tamb(°C)	HC(KW)	PI(KW)	HC(KW)	PI(KW)	HC(KW)	PI(KW)	HC(KW)	PI(KW)	HC(KW)	PI(KW)	HC(KW)	PI(KW)	HC(KW)	PI(KW)	HC(KW)	PI(KW)
-20	3.57	1.42	3.40	1.60	3.41	1.69	3.43	1.98									
-15	4.47	1.63	4.26	1.83	4.12	1.92	3.99	2.00	3.87	2.10							
-10	5.15	1.69	4.90	1.90	4.75	1.99	4.61	2.08	4.47	2.18	4.15	2.39					
-7	5.36	1.67	5.10	1.88	4.99	2.12	4.88	2.36	4.78	2.58	4.67	2.79					
-2	5.20	1.48	4.95	1.67	4.76	1.83	4.58	1.99	4.35	2.24	4.12	2.49	3.90	2.76			
2	5.04	1.29	4.80	1.45	4.54	1.54	4.27	1.62	4.06	1.82	3.84	2.03	3.64	2.25			
7	5.25	0.92	5.00	1.03	4.90	1.17	4.80	1.30	4.55	1.41	4.30	1.52	4.08	1.56	3.85	1.60	
10	5.73	0.92	5.46	1.04	5.38	1.18	5.29	1.31	5.03	1.48	4.76	1.64	4.53	1.69	4.29	1.74	
15	6.54	0.94	6.23	1.05	6.17	1.18	6.12	1.33	5.81	1.50	5.51	1.66	5.23	1.72	4.95	1.77	
20	7.35	0.95	7.00	1.07	6.97	1.20	6.94	1.35	6.56	1.52	6.25	1.69	5.93	1.74	5.62	1.79	

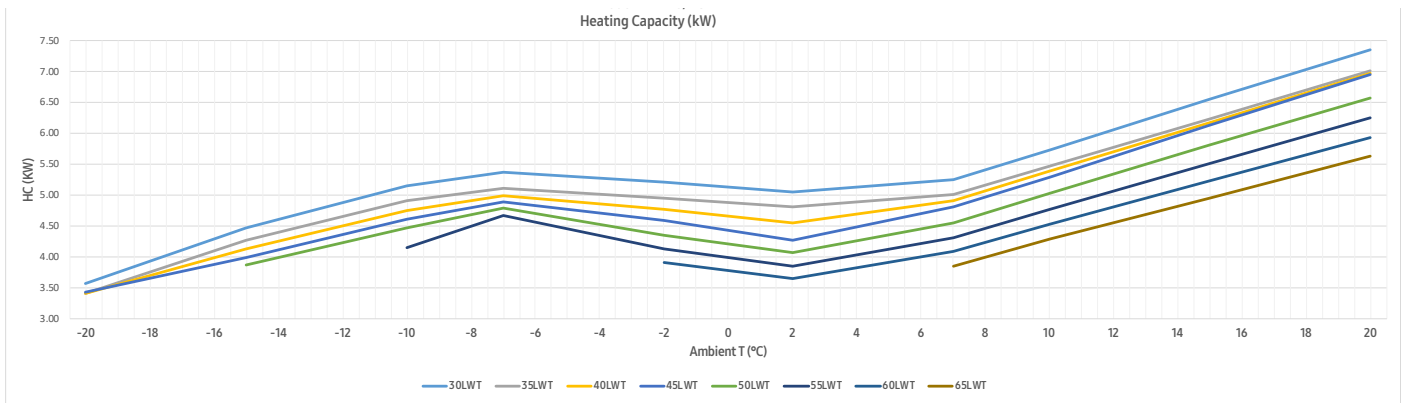

HHSM-G600008-1	LWT(°C) 30		35		40		45		50		55		60		65		
	Tamb(°C)	HC(KW)	PI(KW)	HC(KW)	PI(KW)	HC(KW)	PI(KW)	HC(KW)	PI(KW)	HC(KW)	PI(KW)	HC(KW)	PI(KW)	HC(KW)	PI(KW)	HC(KW)	PI(KW)
-20	5.60	2.21	5.33	2.48	5.27	2.70	5.20	3.13									
-15	6.56	2.42	6.25	2.72	6.15	2.94	6.06	3.16	5.88	3.32							
-10	7.86	2.66	7.49	2.99	7.26	3.14	7.04	3.28	6.83	3.45	6.33	3.77					
-7	7.72	2.69	7.35	3.02	7.13	3.17	6.91	3.32	6.31	3.56	5.71	3.85					
-2	7.53	2.39	7.18	2.69	6.94	2.83	6.71	2.97	6.37	3.34	6.03	3.71	5.72	4.13			
2	7.35	2.09	7.00	2.35	6.75	2.49	6.50	2.62	6.18	2.95	5.85	3.28	5.54	3.64			
7	8.40	1.58	8.00	1.70	7.70	1.95	7.40	2.12	7.25	2.33	7.10	2.53	6.96	2.62	6.81	2.72	
10	9.23	1.57	8.79	1.77	8.53	1.97	8.28	2.17	7.86	2.44	7.45	2.71	7.08	2.79	6.70	2.88	
15	10.60	1.56	10.10	1.76	9.92	1.97	9.74	2.24	9.25	2.52	8.76	2.80	8.33	2.89	7.89	2.98	
20	11.98	1.56	11.41	1.75	11.31	2.01	11.20	2.32	10.64	2.61	10.08	2.90	9.58	2.99	9.07	3.08	

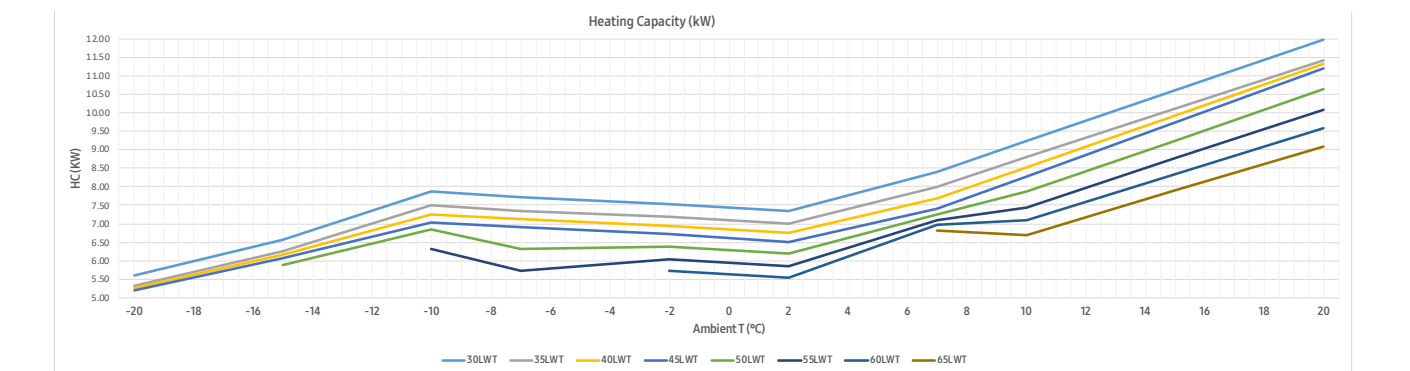

1. Heating capacity: Capacity is according to Eurovent rating standard OM-3-207 5 and valid for heated water range $L_t = 3 - 8^\circ\text{C}$

2. Cooling capacity: Capacity is according to Eurovent rating standard OM-3-207 5 and valid for chilled water range $L_t = 3 - 8^\circ\text{C}$

3. Power input: Power input is according to Eurovent rating standard OM-3-2015.

4. Peak value: Tested without defrost operation in accordance with EN7 457 7
* The real capacity would be changed according to the install environment.

Joule Air Source Heat Pumps - Specification

Maximum Heating Capacity (Integrated Value)

LWT (Leaving Water Temp.), Tamb (Ambient Temp.), HC (Heating Capacity), PI (Power input)

HHSM-G600012-1	LWT(°C) 30		35		40		45		50		55		60		65		
	Tamb(°C)	HC(KW)	PI(KW)	HC(KW)	PI(KW)	HC(KW)	PI(KW)	HC(KW)	PI(KW)	HC(KW)	PI(KW)	HC(KW)	PI(KW)	HC(KW)	PI(KW)	HC(KW)	PI(KW)
-20	9.82	4.08	9.35	4.58	9.04	4.68	8.72	4.88									
-15	11.02	4.21	10.49	4.73	10.33	4.83	10.16	4.93	9.85	5.18							
-10	12.14	4.23	11.56	4.75	11.22	4.94	10.87	5.12	10.54	5.38	9.78	5.89					
-7	12.60	4.19	12.00	4.71	11.47	5.18	10.94	5.64	10.41	6.11	9.87	6.57					
-2	11.97	3.56	11.40	4.01	11.19	4.48	10.98	4.95	10.43	5.56	9.88	6.18	9.36	6.87			
2	11.34	2.94	10.80	3.30	10.91	3.78	11.02	4.25	10.47	4.78	9.92	5.31	9.40	5.90			
7	12.60	2.36	12.00	2.65	11.85	2.92	11.70	3.18	11.50	3.46	11.30	3.73	11.11	3.83	10.91	3.94	
10	13.91	2.34	13.25	2.63	13.06	2.88	12.87	3.14	12.22	3.53	11.58	3.92	11.00	4.05	10.42	4.17	
15	16.09	2.30	15.32	2.59	15.07	2.79	14.81	3.07	14.07	3.45	13.33	3.84	12.66	3.96	11.99	4.08	
20	18.27	2.27	17.40	2.55	17.08	2.75	16.75	3.00	15.91	3.38	15.08	3.75	14.32	3.87	13.57	3.98	

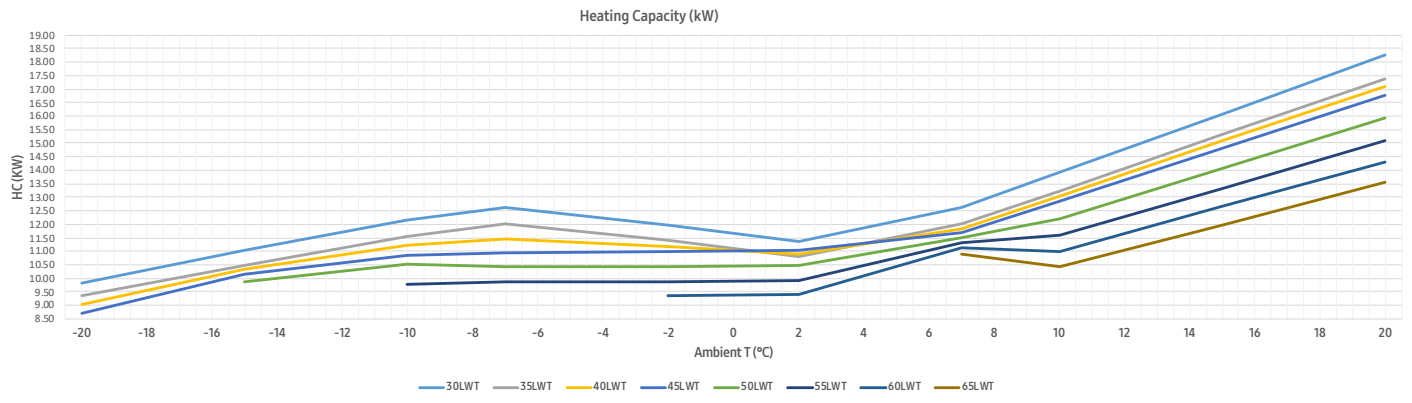

HHSM-G600016-1	LWT(°C) 30		35		40		45		50		55		60		65		
	Tamb(°C)	HC(KW)	PI(KW)	HC(KW)	PI(KW)	HC(KW)	PI(KW)	HC(KW)	PI(KW)	HC(KW)	PI(KW)	HC(KW)	PI(KW)	HC(KW)	PI(KW)	HC(KW)	PI(KW)
-20	11.87	5.05	11.30	5.67	10.99	6.04	10.68	6.61									
-15	13.51	5.29	12.87	5.94	12.66	6.31	12.44	6.67	12.07	7.01							
-10	14.82	5.36	14.11	6.03	13.67	6.48	13.27	6.94	12.87	7.28	11.94	7.98					
-7	15.33	5.34	14.60	6.00	14.66	6.77	14.71	7.53	13.79	7.64	12.86	7.75					
-2	14.60	4.63	13.90	5.20	13.41	5.65	12.93	6.10	12.28	6.86	11.63	7.62	11.02	8.47			
2	13.86	3.92	13.20	4.40	12.17	4.53	11.14	4.66	10.58	5.24	10.03	5.83	9.50	6.47			
7	16.80	3.22	16.00	3.62	15.70	4.06	15.40	4.49	15.20	4.84	15.00	5.18	14.81	5.28	14.61	5.38	
10	18.25	3.26	17.38	3.66	17.09	4.10	16.80	4.54	15.96	5.10	15.12	5.67	14.37	5.82	13.61	6.02	
15	20.68	3.33	19.69	3.74	19.42	4.11	19.14	4.61	18.18	5.19	17.23	5.77	16.37	5.95	15.50	6.13	
20	23.10	3.39	22.00	3.81	21.74	4.21	21.48	4.69	20.41	5.28	19.33	5.86	18.37	6.05	17.40	6.23	

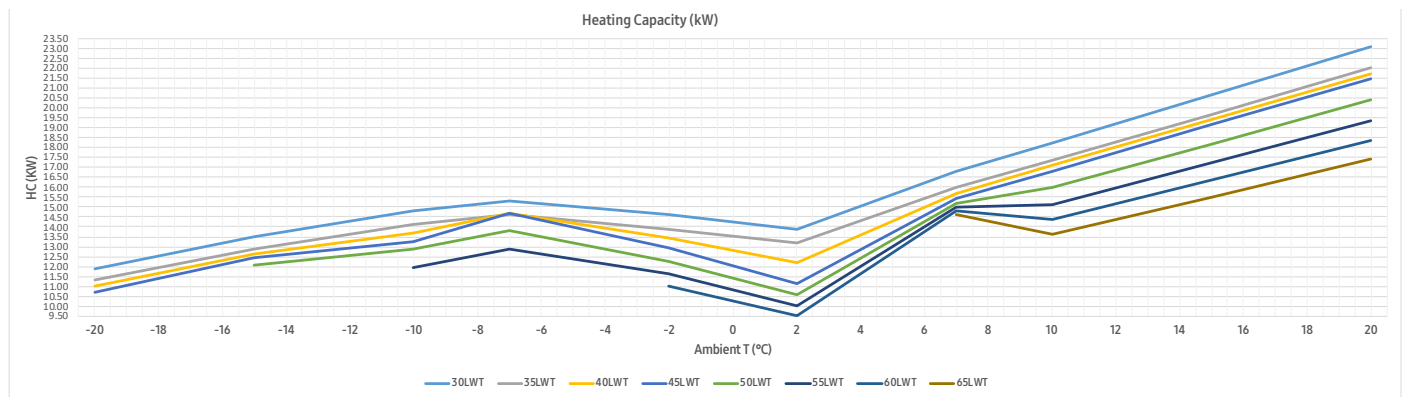

1. Heating capacity: Capacity is according to Eurovent rating standard OM-3-207 5 and valid for heated water range $L_t = 3-8^{\circ}\text{C}$

2. Cooling capacity: Capacity is according to Eurovent rating standard OM-3-207 5 and valid for chilled water range $L_t = 3-8^{\circ}\text{C}$

3. Power input: Power input is according to Eurovent rating standard OM-3-2015.

4. Peak value: Tested without defrost operation in accordance with EN7 457 7
* The real capacity would be changed according to the install environment.

Silent mode

In this mode max compressor frequency and max outdoor unit fan speed are limited. Performance is reduced as the maximum compressor frequency decreases (35% decreases).

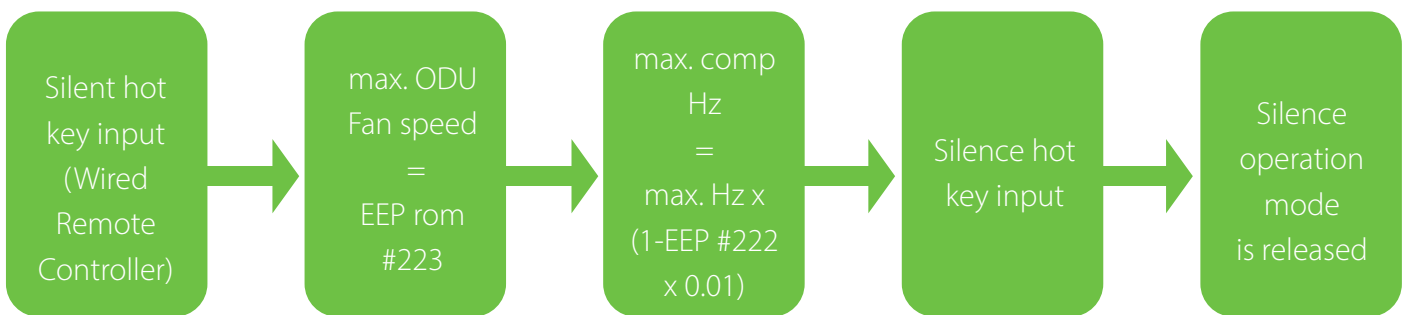
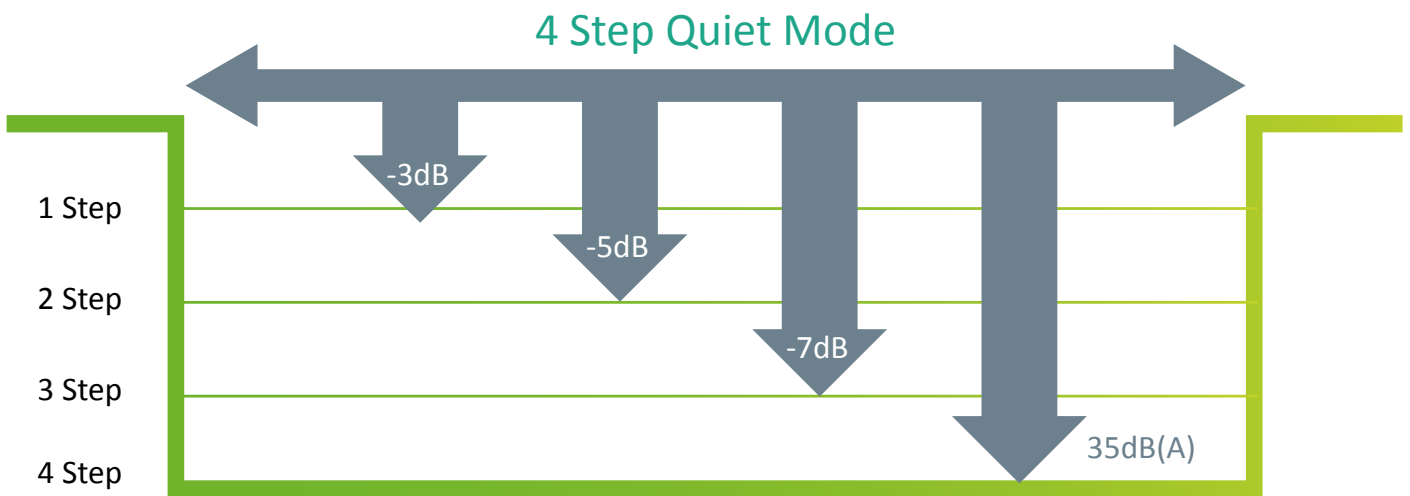

Step 1	Step 2	Step 3
-3dB	-35dB	-7dB

Joule Air Source Heat Pumps - Sound Data

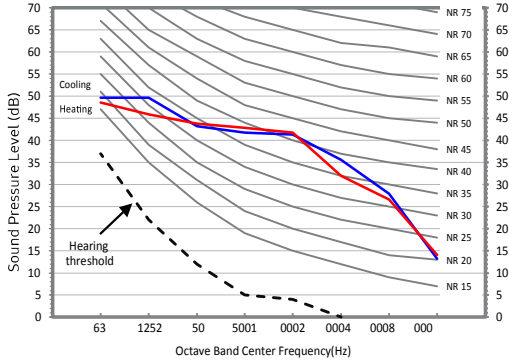

HHSM-G600005-1

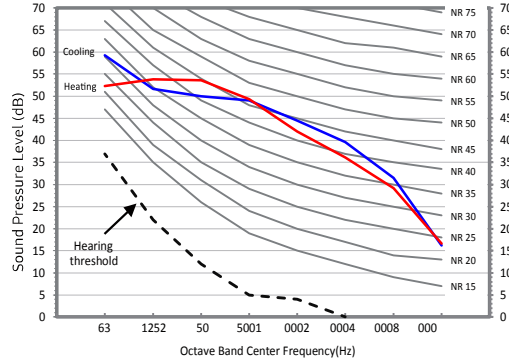

HHSM-G600008-1

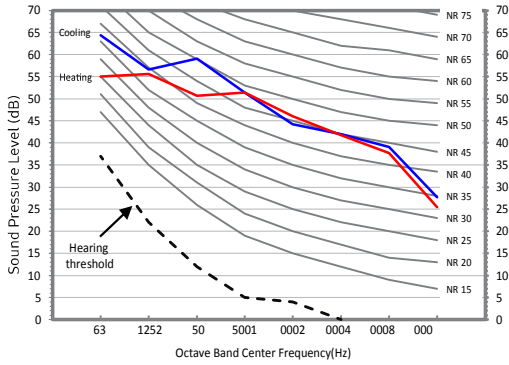

HHSM-G600012-1

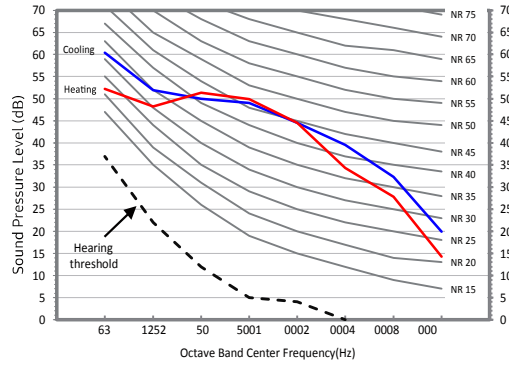

HHSM-G600016-1

Model	Emitter Category	Maximum Output
AE050RXYDEG	Flow temperature $\leq 55^{\circ}\text{C}$	4.400
AE050RXYDEG	Flow temperature $\leq 45^{\circ}\text{C}$	4.830
AE050RXYDEG	Flow temperature $\leq 35^{\circ}\text{C}$	5.090
AE080RXYDEG	Flow temperature $\leq 55^{\circ}\text{C}$	7.270
AE080RXYDEG	Flow temperature $\leq 45^{\circ}\text{C}$	7.970
AE080RXYDEG	Flow temperature $\leq 35^{\circ}\text{C}$	7.270
AE120RXYDEG	Flow temperature $\leq 55^{\circ}\text{C}$	10.580
AE120RXYDEG	Flow temperature $\leq 45^{\circ}\text{C}$	11.610
AE120RXYDEG	Flow temperature $\leq 35^{\circ}\text{C}$	11.690
AE160RXYDEG	Flow temperature $\leq 55^{\circ}\text{C}$	14.180
AE160RXYDEG	Flow temperature $\leq 45^{\circ}\text{C}$	15.550
AE160RXYDEG	Flow temperature $\leq 35^{\circ}\text{C}$	14.430

Joule Cylinders- Standard Pre-Plumb

Standard Pre-Plumbed Cylinder For Joule Samsung Monobloc Units

Joule hot water cylinders are next generation in pre-plumbed hot water solutions. With its sleek design and pre-plumbed architecture the space requirements for the pre-plumbed hot water cylinder have been reduced dramatically.

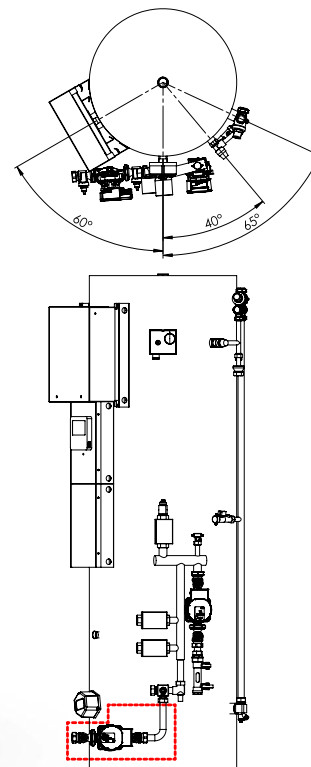

CYLINDER		HUGH-G6150-L3C	HUGH-G6170-L3C	HUGH-G6200-L3C	HUGH-G6250-N3C	HUGH-G6300-N3C	
NOMINAL HOT WATER VOLUME (LITRES)		150	170	200	250	300	
ErP RATING		C	C	C	C	C	
STANDING LOSS (W)		55	66	81	89	92	
HEAT UP TIME (MINS)		10	10	11	14	17	
WATER		Primary Circuit Pump	Wilo- Yonos PARA RS 15/7.0 iPWM1 130 12				
		Heating Circuit Pump					
		Connection Size (mm) Heating / DHW		22 / 22			
WATER SAFETY	Water Circuit	Control Thermistor (°C)	80				
		DHW Expansion Vessel (Litres)	18	18	18	18	24
	DHW Cylinder	Control Thermistor (°C)	75	75	75	75	75
		Over Temperature Cut-Out (°C)	80 ± 5				
		Temp and Pressure Relief Valve (°C) / (MPa (Bar))	90 / 1.0 (10)				
		Expansion Relief Valve (Cold) (MPa (Bar))	0.6 (6)				
DIMENSIONS (mm)		Height	1190	1310	1490	1815	1600
		Width	540	530	540	540	600
WEIGHT EMPTY / FULL (kg)		46/196	54/223	58/256	67/316	74/372	
CYLINDER MATERIAL	Cylinder	Stainless Steel Duplex LDX 2101					
	Insulation	Insulation Type	Polyurethane foam CFC-Free and HCFC Free				
		Insulation Thickness (mm)	50				
		GWP of Insulation	3.1				
		ODP of Insulation	0				
ELECTRICAL DATA		Electrical Supply MIM	220-240v, 50Hz				
		Phase	Single				
		Fuse Rating - MCB Sizes (A)*1	16				
		Imerssion Capacity (kW)	3				
		Max Running Current (A)	13				
		Fuse Rating - MCB Sizes (A)*1	16				

Joule Cylinders- Slimline Pre-Plumb

Slimline Pre-Plumbed Cylinder For Joule Samsung Monobloc Units

Joule Cyclone Slimline cylinders have been designed for the use in tight areas where there is more height than width available.

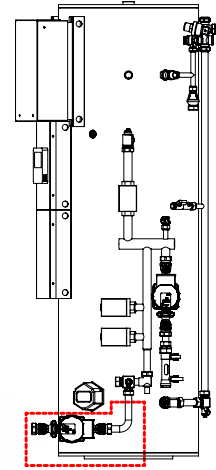
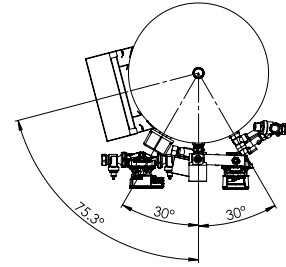

CYLINDER		HUGH-G6150-S3C	HUGH-G6170-S3C	HUGH-G6205-S3C		
NOMINAL HOT WATER VOLUME (LITRES)		150	170	205		
ErP RATING		C	C	C		
Standing Loss (W)		70	79	84		
Heat Up Time (mins)		26	27	31		
WATER		Primary Circuit Pump	Wilo- Yonos PARA RS 15/7.0 iPWM1 130 12			
		Heating Circuit Pump				
		Connection Size (mm) Heating / DHW			22 / 22	
WATER SAFETY	Water Circuit	Control Thermistor (°C)	80			
		DHW Expansion Vessel (Litres)	18			
	DHW Cylinder	Control Thermistor (°C)	75			
		Over Temperature Cut-Out (°C)	80 ± 5			
		Temp and Pressure Relief Valve (°C) / (MPa (Bar))	90 / 1.0 (10)			
		Expansion Relief Valve (Cold) (MPa (Bar))	0.6 (6)			
DIMENSIONS (mm)		Height	1335	1535	1880	
		Width	475			
WEIGHT EMPTY / FULL (kg)		35 / 175	39 / 199	43 / 230		
CYLINDER MATERIAL		Cylinder	Stainless Steel Duplex LDX 2101			
		Insulation	Insulation Type	Polyurethane foam CFC-Free and HCFC Free		
			Insulation Thickness (mm)	50		
			GWP of Insulation	3.1		
			ODP of Insulation	0		
ELECTRICAL DATA		Electrical Supply	220-240v, 50Hz			
		Phase	Single			
		Fuse Rating - MCB Sizes (A)*1	16			
		Capacity (kW)	3			
		Max Running Current (A)	13			
		Fuse Rating - MCB Sizes (A)*1	16			

Joule Cylinders- Smart Plumb Pre-plumb Compact

Compact Pre-Plumbed Cylinder For Joule Samsung Monobloc Units

The new and innovative Smart Plumb Compact has been designed to not only look modern and minimise footprint for homeowners, but it also has been designed to benefit installers.

Having all main components easily accessible proves maintenance simple, as well as strategically assigning all valves to be part of one unit concludes everything being in a single place logically makes the job at hand simple, less time consuming and cost effective.

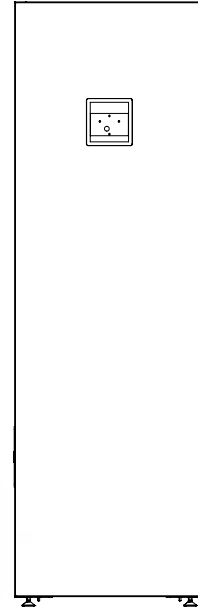
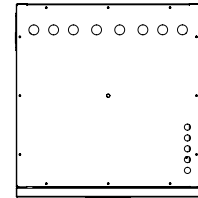

CYLINDER		HUGH-180COM-3C	HUGH-230COM-3C	
NOMINAL HOT WATER VOLUME (LITRES)		180L	230L	
HEAT PUMP COMBINATION HEATER - Large Profile (Average Climate) ErP Rating		C		
OPERATING AMBIENT TEMPERATURE (°C DB)		0 ~ +35°C (RH<80%)	0 ~ +35°C (RH<80%)	
SOUND PRESSURE LEVEL AT 1M (dBA)		28	28	
WATER		Primary Circuit Pump	willo- Yonos PARA RS 15/7.0 iPWM1 130 12	
		Sanitary Hot Water Pump		
Connection Size (mm) Heating / DHW		28 / 22	28 / 22	
WATER SAFETY DEVICES	Water Circuit	Control Thermistor (°C)	1 - 80	1 - 80
		Flow Sensor (minimum flow 5L/min)	Supplied	Supplied
	DHW Cylinder	Control Thermistor (°C)	75	75
		Temp and Pressure Relief Valve (°C)/ (MPa (Bar))	90 / 0.7 (7)	
DIMENSIONS (mm)		Width	595mm	
		Height	1900mm	
WEIGHT EMPTY / FULL (kg)		85/ 265	90/ 320	
ELECTRICAL DATA		Electrical Supply	220-240v, 50Hz	
		Phase	Single	
		Fuse Rating - MCB Sizes (A)*1	10	
		Immersion Capacity (kW)	3	
		Max Running Current (A)	13	
		Fuse Rating - MCB Sizes (A)*1	16	

Joule Cylinders - Smart Plumb Pre-plumbed

Smart Plumb Pre-Plumbed Cylinder For Joule Samsung Monobloc Units

The Smart Plumb by Joule is the most innovative pre-plumbed solution for heat pump systems. The cylinder / buffer combo is pre-plumbed, wired and commissioned before it leaves the factory.

The buffer / low loss header acts as an intermediary vessel for the heating system which helps system flow rate and defrost cycling. With the cylinder sitting over the buffer tank the foot print has been greatly reduced. The control wires are all hidden behind the cable cover.

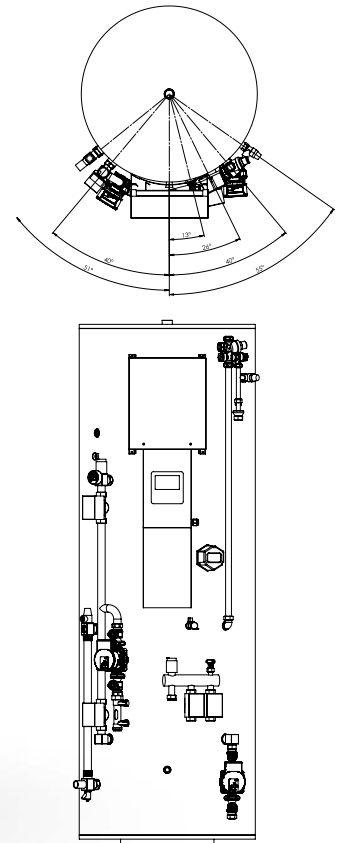

CYLINDER		HUGH-G61860-3C	HUGH-G62060-3C	HUGH-G62590-3C	HUGH-G64013-3C	HUGH-G64013-3C	
NOMINAL HOT WATER VOLUME (LITRES)		180L/60L	200L/60L	250L/90L	300L/130L	400L/130L	
ErP RATING		B/B	C/B	C/B	C/B	C/B	
HEAT UP TIME - COIL (MINS)		55	66	87	102		
STANDING LOSS (W)		10	10	14	19		
WATER		Primary Circuit Pump	Wilo - Yonos PARA RS 15/7.0 iPWM1 130 12				
		Heating Circuit Pump					
		Connection Size (mm) Heating / DHW					22/22
WATER SAFETY	Water Circuit	Control Thermistor (°C)	80				
		DHW Expansion Vessel (Litres)	18				
	DHW Cylinder	Control Thermistor (°C)	75				
		Over Temperature Cut-Out (°C)	80 ± 5				
		Temp and Pressure Relief Valve (°C) / (MPa (Bar))	90 / 1.0 (10)				
		Expansion Relief Valve (Cold) (MPa (Bar))	0.6 (6)				
DIMENSIONS (mm)		Width	540	540	600	710	710
		Height	1870	1980	1950	1850	2160
WEIGHT EMPTY / FULL (kg)							
CYLINDER MATERIAL		Cylinder	Stainless Steel Duplex LDX 2101				
		Insulation	Cylinder Material	Polyurethane foam CFC-Free and HCFC Free			
			Insulation Type				
			Insulation Thickness (mm)	50			
			GWP of Insulation	3.1			
		ODP of Insulation	0				
ELECTRICAL DATA		Electrical Supply	220-240v, 50Hz				
		Phase	Single				
		Fuse Rating - MCB Sizes (A)*1	16				
		Immersion Capacity (kW)	3				
		Max Running Current (A)	13				
		Fuse Rating - MCB Sizes (A)*1	16				

Outdoor Unit Key Technical Features

- Dimensions HxWxD (mm): 798x 880 x 310*1
- Sound Pressure Level at 1M: 45 DBA
- Low maintenance and quiet operation
- ErP: A+++ (35°C)
- Breaker: 20 Amp
- Recommended pipe size: 28 mm
- Nominal flow rate: 21L/min

INCLUDED COMPONENTS					
Type	Description	Packaged	Pre-Plumbed	Standalone	Buffer
Electrical	Immersion Heater	●	●		●
	Wifi ready System Controller	●	●	●	●
	Water Temperature Thermistor	●	●	●	●
	Flow & Return Water Temperature Thermistor	●	●	●	●
Mechanical	Filter Y-Strainer	●	●	●	●
	Insulated Flexible Connection Pipes	●	●	●	●
	Flow Sensor	●	●	●	●
	Primary Circulating Pump	●	●		●
	Heating Circulating Pump	●	●		●
	Zone Valves	●	●		●
	Low Loss Header		●		
	Buffer Tank				●
	Domestic Hot Water Expansion Vessel	●	●		●
	Primary Expansion Vessel	●			
	Primary System Pressure Gauge	●	●		●
	Filling Loop	●	●		●
	Automatic Air-Vent	●	●		●
	Drain Valve	●	●		●
	Pressure Reducing Valve	●	●		●
	Temperature / Pressure Relief Valve	●	●		●
	Tundish	●	●		●

*1 exc. grille. *2 Recommended breaker rating for outdoor unit / Indoor unit

*3 Outdoor unit F&R / Indoor unit F&R.

Joule-Samsung 8kW Monobloc Air Source Heat Pump

HHSM-G600008-1



Solution Key Features

- 7 year Warranty
- SCOP: Best on MCS Database – 4.52
- 65°C Hot Water
- <48DbdB - Quietest System on the Market
- 8Kw Outputs
- Low GWP Refrigerant – R32

SYSTEM PRICE			INDOOR UNIT				
Ref Code	Ref Code Description	Dimensions (H x W x D)	Breaker (A) ^{*2}	Pipe Size (mm) ^{*3}	Price (£)		
Packaged							
HXSM-G6-012*	(HXSM-G6-017)*	SAMSUNG MONO 8 - 6.37KW 1PH 180L COMPACT	1900 x 595 x 625	16 & 16	28 / 22	£5,897.49	(£6,297.49)
HXSM-G6-132*	(HXSM-G6-137)*	SAMSUNG MONO 8 - 6.37KW 1PH 230L COMPACT	1900 x 595 x 625	16 & 16	28 / 22	£5,897.49	(£6,297.49)
Pre-Plumbed							
HXSM-G6-034*	(HXSM-G6-051)*	SAMSUNG MONO 8 - 6.37KW 1PH 150L STANDARD	1130 x 683 x 730	16 & 16	28 / 22	£5,250.96	(£5,650.96)
HXSM-G6-035*	(HXSM-G6-052)*	SAMSUNG MONO 8 - 6.37KW 1PH 170L STANDARD	1256 x 683 x 730	16 & 16	28 / 22	£5,316.56	(£5,716.56)
HXSM-G6-036*	(HXSM-G6-053)*	SAMSUNG MONO 8 - 6.37KW 1PH 200L STANDARD	1508 x 683 x 730	16 & 16	28 / 22	£5,380.98	(£5,780.98)
HXSM-G6-037*	(HXSM-G6-054)*	SAMSUNG MONO 8 - 6.37KW 1PH 250L STANDARD	1760 x 683 x 730	16 & 16	28 / 22	£5,464.29	(£5,864.29)
HXSM-G6-023*	(HXSM-G6-028)*	SAMSUNG MONO 8 - 6.37KW 1PH 150L SLIMLINE	1515 x 648 x 645	16 & 16	28 / 22	£5,250.96	(£5,650.96)
HXSM-G6-024*	(HXSM-G6-029)*	SAMSUNG MONO 8 - 6.37KW 1PH 170L SLIMLINE	1689 x 648 x 645	16 & 16	28 / 22	£5,316.56	(£5,716.56)
HXSM-G6-067*	(HXSM-G6-081)*	SAMSUNG MONO 8 - 6.37KW 1PH 210L SOLAR	1510 x 545	16 & 16	28 / 22	£5,578.99	(£5,978.99)
HXSM-G6-068*	(HXSM-G6-082)*	SAMSUNG MONO 8 - 6.37KW 1PH 250L SOLAR	1760 x 545	16 & 16	28 / 22	£5,936.14	(£6,336.14)
HXSM-G6-069*	(HXSM-G6-083)*	SAMSUNG MONO 8 - 6.37KW 1PH 300L SOLAR	1980 x 545	16 & 16	28 / 22	£6,364.71	(£6,764.71)
Standalone							
HXSM-G6-002**	(HXSM-G6-007)**	SAMSUNG MONO 8 - 6.37KW 1PH SO SYS	422 x 393 x 87	Via ODU or 16	28 / 22	£3,641.79	(£4,041.79)
Buffer							
HXSM-G6-095*	(HXSM-G6-110)*	SAMSUNG MONO 8 - 6.37KW 1PH JOULE HP MONO 180/60L	1870 x 540	16 & 16	28 / 22	£6,102.28	(£6,502.28)
HXSM-G6-096*	(HXSM-G6-111)*	SAMSUNG MONO 8 - 6.37KW 1PH JOULE HP MONO 200/60L	1980 x 540	16 & 16	28 / 22	£6,166.69	(£6,566.69)
HXSM-G6-097*	(HXSM-G6-112)*	SAMSUNG MONO 8 - 6.37KW 1PH JOULE HP MONO 250/90L	1670 x 600	16 & 16	28 / 22	£6,250.00	(£6,650.00)
HXSM-G6-123*	(HXSM-G6-127)*	SAMSUNG MONO 8 - 6.37KW 1PH JOULE HP MONO 300/130L	1850 x 710	16 & 16	28 / 22	£7,150.00	(£7,607.14)

Included Components*:

Outdoor Unit, Insulated Flexible Connection Pipes, 1"Y Pattern Strainer With Isolation and Pre Plumbed Cylinder

Included Components:**

Outdoor Unit, Insulated Flexible Connection Pipes, 1"Y Pattern Strainer With Isolation and Mono Control Center

Recommended Components:

20l Concentrate Hp Fluid and Anti-Vibration Fix-It Foot 600mm Kit

Outdoor Unit Key Technical Features

- Dimensions HxWxD (mm): 998 x 940 x 330*1
- Sound Pressure Level at 1m: 48 dBA
- ErP: A+++ (35°C)
- Breaker: 25 Amp
- Recommended pipe size: 28mm
- Nominal flow rate: 24L/min

INCLUDED COMPONENTS					
Type	Description	Packaged	Pre-Plumbed	Standalone	Buffer
Electrical	Immersion Heater	●	●		●
	Wifi ready System Controller	●	●	●	●
	Water Temperature Thermistor	●	●	●	●
	Flow & Return Water Temperature Thermistor	●	●	●	●

Mechanical	Filter Y-Strainer	●	●	●	●
	Insulated Flexible Connection Pipes	●	●	●	●
	Flow Sensor	●	●	●	●
	Primary Circulating Pump	●	●		●
	Heating Circulating Pump	●	●		●
	Zone Valves	●	●		●
	Low Loss Header		●		
	Buffer Tank				●
	Domestic Hot Water Expansion Vessel	●	●		●
	Primary Expansion Vessel	●			
	Primary System Pressure Gauge	●	●		●
	Filling Loop	●	●		●
	Automatic Air-Vent	●	●		●
	Drain Valve	●	●		●
	Pressure Reducing Valve	●	●		●
	Temperature / Pressure Relief Valve	●	●		●
	Tundish	●	●		●

*1 exc. grille. *2 Recommended breaker rating for outdoor unit / Indoor unit

*3 Outdoor unit F&R / Indoor unit F&R.

Outdoor Unit Key Technical Features

- Dimensions HxWxD (mm): 1420 x 940 x 330*1
- Sound Pressure Level at 1m: 50 dBA
- ErP: A+++ (35°C)
- Breaker: 32 Amp
- Recommended pipe size: 28mm
- Nominal flow rate: 25L/min

INCLUDED COMPONENTS					
Type	Description	Packaged	Pre-Plumbed	Standalone	Buffer
Electrical	Immersion Heater	●	●		●
	Wifi ready System Controller	●	●	●	●
	Water Temperature Thermistor	●	●	●	●
	Flow & Return Water Temperature Thermistor	●	●	●	●
Mechanical	Filter Y-Strainer	●	●	●	●
	Insulated Flexible Connection Pipes	●	●	●	●
	Flow Sensor	●	●	●	●
	Primary Circulating Pump	●	●		●
	Heating Circulating Pump	●	●		●
	Zone Valves	●	●		●
	Low Loss Header		●		
	Buffer Tank				●
	Domestic Hot Water Expansion Vessel	●	●		●
	Primary Expansion Vessel	●			
	Primary System Pressure Gauge	●	●		●
	Filling Loop	●	●		●
	Automatic Air-Vent	●	●		●
	Drain Valve	●	●		●
	Pressure Reducing Valve	●	●		●
	Temperature / Pressure Relief Valve	●	●		●
	Tundish	●	●		●

*1 exc. grille. *2 Recommended breaker rating for outdoor unit / Indoor unit

*3 Outdoor unit F&R / Indoor unit F&R.

Outdoor Unit Key Technical Features

- Dimensions HxWxD (mm): 1420 x 940 x 330*1
- Sound Pressure Level at 1m: 52 dBA
- ErP: A+++ (35°C)
- Breaker: 32 Amp
- Recommended pipe size: 28mm
- Nominal flow rate: 25L/min

INCLUDED COMPONENTS					
Type	Description	Packaged	Pre-Plumbed	Standalone	Buffer
Electrical	Immersion Heater	●	●		●
	Wifi ready System Controller	●	●	●	●
	Water Temperature Thermistor	●	●	●	●
	Flow & Return Water Temperature Thermistor	●	●	●	●
Mechanical	Filter Y-Strainer	●	●	●	●
	Insulated Flexible Connection Pipes	●	●	●	●
	Flow Sensor	●	●	●	●
	Primary Circulating Pump	●	●		●
	Heating Circulating Pump	●	●		●
	Zone Valves	●	●		●
	Low Loss Header		●		
	Buffer Tank				●
	Domestic Hot Water Expansion Vessel	●	●		●
	Primary Expansion Vessel	●			
	Primary System Pressure Gauge	●	●		●
	Filling Loop	●	●		●
	Automatic Air-Vent	●	●		●
	Drain Valve	●	●		●
	Pressure Reducing Valve	●	●		●
	Temperature / Pressure Relief Valve	●	●		●
	Tundish	●	●		●

*1 exc. grille. *2 Recommended breaker rating for outdoor unit / Indoor unit

*3 Outdoor unit F&R / Indoor unit F&R.

